



**ALL SAINTS'
COLLEGE**

WACE PHYSICS Stage 3

Semester 1 Examination, 2015

Question/Answer Booklet

Student Number: In figures

--	--	--	--	--	--	--	--

In words

Time allowed for this paper

Reading time before commencing work: ten minutes

Working time for paper: three hours

Materials required/recommended for this paper

To be provided by the supervisor

This Question/Answer Booklet

Formulae and Constants Sheet

To be provided by the candidate

Standard items: pens, pencils, eraser, correction fluid, ruler, highlighters, mathaid

Special items: non-programmable calculators satisfying the conditions set by the School Curriculum Standards Authority for this course

Important note to candidates

No other items may be taken into the examination room. It is **your** responsibility to ensure that you do not have any unauthorised notes or other items of a non-personal nature in the examination room. If you have any unauthorised material with you, hand it to the supervisor **before** reading any further.

Structure of this paper

Section	Number of questions available	Number of questions to be answered	Suggested working time (minutes)	Marks available	Percentage of exam
Section One: Short response	13	13	54	54	30
Section Two: Problem-solving	7	7	90	90	50
Section Three: Comprehension	2	2	36	36	20
				180	100

Raw exam score: _____

Marks removed for inappropriate significant figures = _____

Marks removed for inappropriate units = _____

Total = _____

_____ %

Instructions to candidates

- The rules for the conduct of Western Australian external examinations are detailed in the *Year 12 Information Handbook 2015*. Sitting this examination implies that you agree to abide by these rules.
- Write answers in this Question/Answer Booklet.
- You must be careful to confine your responses to the specific questions asked and follow any instructions that are specific to a particular question.
- Working or reasoning should be clearly shown when calculating or estimating answers. It is suggested that answers to calculations are given to 3 significant figures except when you are required to estimate. For estimation questions an appropriate number of significant figures must be stated.
- Spare pages are included at the end of the booklet. They can be used for planning your responses and/or as additional space if required to continue an answer.
 - Planning: If you use the spare pages for planning, indicate this clearly.
 - Continuing an answer: If you need to use the space to continue an answer, indicate in the original answer space where the answer is continued, i.e. give the page number. Refer to the question(s) where you are continuing your work.

Section One: Short response

30% (54 Marks)

This section has **13** questions. Answer **all** questions. Write your answers in the space provided. Suggested working time for this section is 54 minutes.

Question 1

An aircraft is travelling at 83 m s^{-1} and is attempting to land on a runway that is running due West. A strong wind is blowing at 28 m s^{-1} in a direction North 10° East (10° true). Calculate the direction that the aircraft must travel to ensure that its resultant velocity is due West. You must refer to a vector diagram in your solution.

(4)

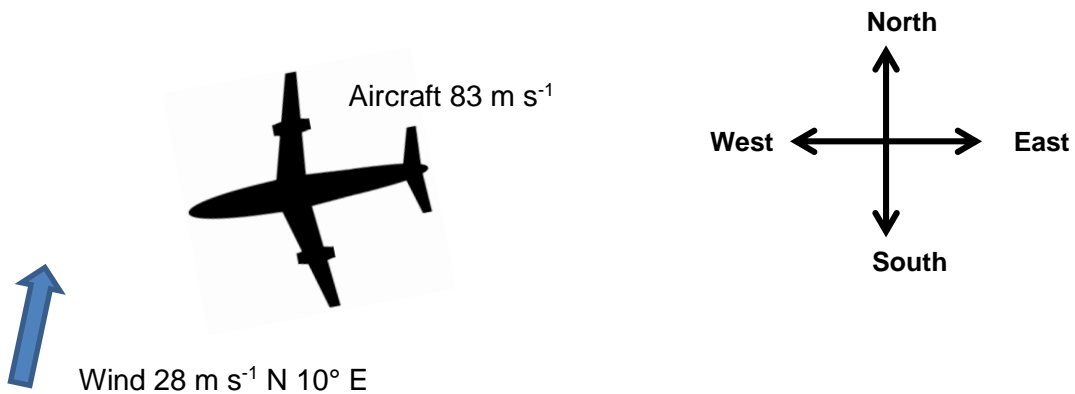

Description	Marks
	1
$\frac{28}{\sin B} = \frac{83}{\sin 100}$ $B = \sin^{-1}(28 \times \sin 100 / 83)$ $B = 19.4^\circ$	1-2
recognize Z of angles	
<i>direction = W 19.4° S (S 70.6 W or 252 True)</i>	1
Total	4

Question 2

A cross country runner is going around a circular segment of a curve at a constant speed of 18 km h^{-1} and with an acceleration of 1.40 m s^{-2} towards the centre. Determine the radius of the curve.

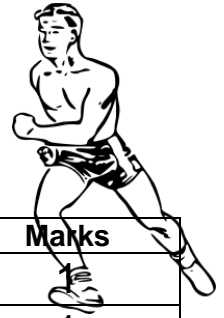

Description	Marks
$v = 18 \text{ km h}^{-1} = 5.00 \text{ m s}^{-1}$	
$a = \frac{v^2}{r}$ $r = \frac{v^2}{a}$ $= \frac{5^2}{1.4}$	1
$= 17.9 \text{ m}$	1
Total	3

3)

Question 3

The diagram shows a simple electrical circuit that comprises of a battery and three resistors. A voltmeter is connected across one of the resistors. Appropriate values are detailed on the diagram. Determine the reading on the voltmeter.

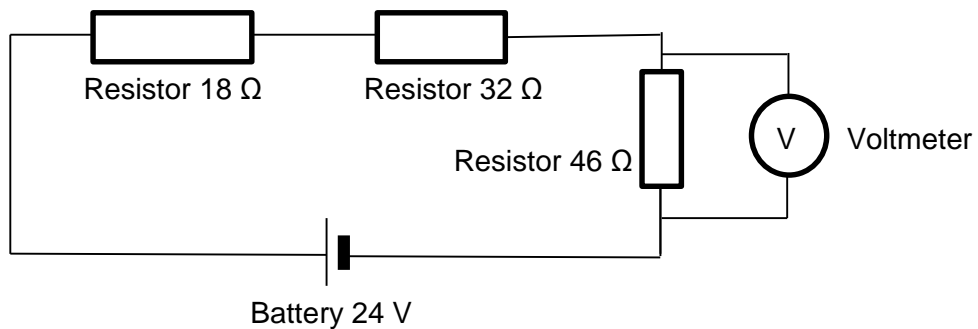

(3)

Description	Marks
Total $R = 18 + 32 + 46 = 96 \Omega$	1
$I \text{ (total)} = V \text{ emf} / R \text{ total} = 24 / 96 = 0.25 \text{ A}$	1
$V_{46 \Omega} = I \cdot R = 0.25 \times 46 = 11.5 \text{ V}$	1
Total	3

Question 4

A jet of mass 8000 kg is banking whilst making a turn at a constant altitude. It follows the segment of a circle and changes direction by 90° in a time of 12 seconds. The banking angle is 19.0° .

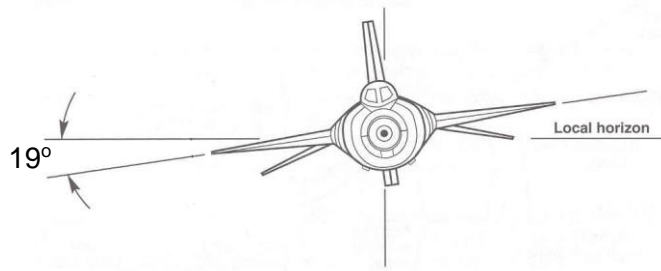

- a) Draw a vector diagram showing the forces acting on the jet and the sum of the forces.

(1)

Description	Marks
	1
Diagram and symbols correct. No angle required.	
Total	1

- b) Calculate the horizontal turning radius of the jet.

(3)

Description	Marks
$T = 4 \times 12 = 48 \text{ s}$	1
$\tan 19 = \frac{mv^2}{r} \times \frac{1}{mg} = \frac{v^2}{gr} = \frac{4\pi^2 r}{gT^2}$ $r = \frac{\tan 19 \cdot g \cdot T^2}{4\pi^2}$ $r = \frac{\tan 19 \times 9.8 \times 48^2}{4\pi^2}$	1
$r = 197 \text{ m}$	1
Total	3

Question 5

An ideal transformer has 5200 turns on the primary coil and 130 turns on the secondary coil. If the voltage output of the secondary coil is 240 V calculate the voltage input to the primary coil.

Description	Marks
$\frac{V_p}{V_s} = \frac{n_p}{n_s}$ $V_p = \frac{n_p}{n_s} V_s$ $= \frac{5200}{130} \times 240$	1
$= 9600 \text{ V}$	1
Total	2

Question 6

The picture shows an athlete training by pulling a truck tyre. A harness attached to her body is connected to the tyre with a strap.



The athlete has a mass of 65.0 kg. The truck tyre has a mass of 30.0 kg. The strap makes an angle of 27.0° with the ground and is transmitting a force of 400 N via tension. She is pulling the tyre forwards at a constant speed of 1.50 m s⁻¹

- a) Calculate the horizontal force that her feet apply to the ground to pull the tyre forwards.

Description	Marks
Considering horizontal forces on athlete that are balanced $F_{\text{pull}} = F_{\text{tension}} \cos 27$ $F_{\text{pull}} = 400 \times \cos 27 = 356.4$	1
$F_{\text{pull}} = 356 \text{ N (backwards)}$	1
Total	2

- b) Calculate the normal reaction force from the ground to the athlete.

Description	Marks
Considering vertical forces on athlete that are balanced Normal reaction up = Weight + Tension component down $N = 65 \times 9.8 + 400 \sin 27 = 818.596$	1
$N = 819 \text{ N (up)}$	1
Total	2

Question 7

The figure shows a 200 mm long metal rod which is free to move to the left and right across frictionless metal rails. The battery supplies 6.00 V to the circuit and the magnetic field strength is 20.0 mT into the page. The resistor has a resistance of 0.200 Ω and the rest of the assembly has negligible resistance.

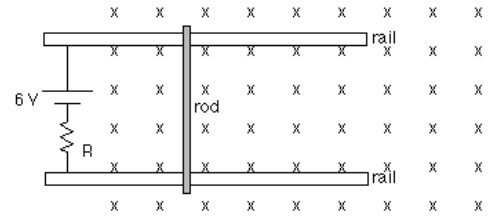

- a) Calculate the magnitude and direction of the electromagnetic force applied to the rod when the rod is stationary

Description	Marks
$I = \frac{V}{R} = \frac{6.00}{0.200} = 30 \text{ A}$	1
$F = ILB$ $= 30 \times 0.2 \times 0.02$	1
$= 0.120 \text{ N (right)}$	1
Total	3

- b) An ammeter was used to measure current through the circuit. It was noticed that the current through the circuit decreases as the speed of the rod increases. Explain this observation.

Description	Marks
As the speed of the rod increases the back emf increases (explain $\text{emf} = lvb$ or $F = qvB$ on charge dragged right in external field into page). The back emf opposes the applied emf and reduces the net voltage available to produce current. Therefore as the speed of the rod increases the current through the circuit decreases.	1-3
Total	3

Question 8

A marble rolls off a desk with a horizontal speed of 1.80 m s⁻¹. The top of the desk is 1.40 m above ground level. Calculate the horizontal distance that the marble will have travelled when it hits the ground.

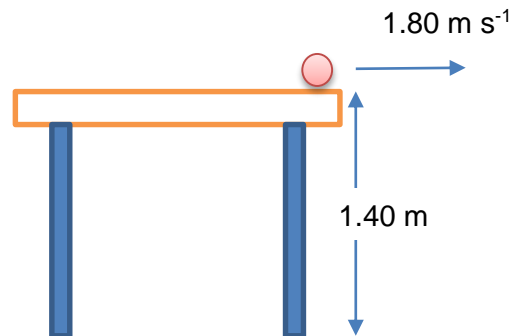

Description	Marks
$u_h = 1.80 \text{ m s}^{-1}$, $u_v = 0 \text{ m s}^{-1}$, $s_v = -1.40 \text{ m}$, $a_v = -9.8 \text{ m s}^{-2}$ $s_v = u_v t + \frac{1}{2} a_v t^2$ $-1.4 = 0 - \frac{1}{2} \times 9.8 \times t^2$ $t = \sqrt{\frac{1.4}{4.90}}$ $= 0.5345225 \text{ s}$	1-2
$s_h = u_h t$ $= 1.80 \times 0.5345225$	1
$= 0.962 \text{ m}$	1
Total	4

Question 9

A charged particle travelling at speed \vec{v} enters a magnetic field of flux density \vec{B} and takes the spiral trajectory shown in the diagram.

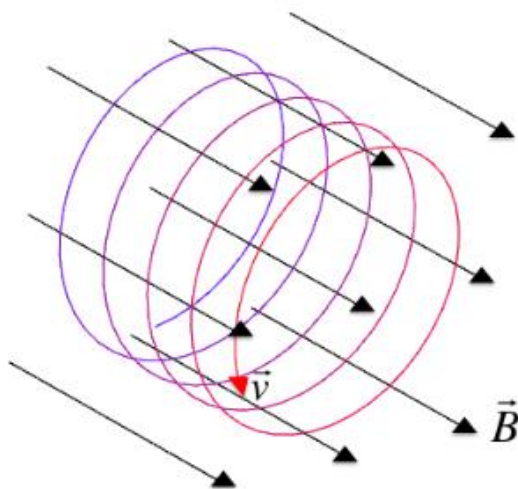

a) With reference to the diagram is the particle positively, negatively or neutrally charged? Circle your answer and explain your choice.

- positive negative neutral impossible to determine

Description	Marks
negative	1
To undergo the spiral trajectory shown the particle must feel a force towards the centre of rotation. Describes use of the right/left hand rule for $F=qvB$ the particle must be negatively charged.	1-2
Total	3

(3)

b) Another particle with a charge of $6.40 \times 10^{-19} C$ enters the magnetic field and undergoes a spiral trajectory. The component of the particle's velocity which is perpendicular to the magnetic field is $2 \times 10^8 m s^{-1}$ and the magnetic flux density is $65.0 \mu T$. Calculate the magnitude of the force applied to the particle.

(2)

Description	Marks
$F = qVB$	1
$= 6.40 \times 10^{-19} \times 2 \times 10^8 \times 65 \times 10^{-6}$	
$= 8.32 \times 10^{-15} N$	1
	2

Question 10

As shown in the figure, Ashley drops two identical, circular magnets down a frictionless copper pole and a frictionless plastic pole.

- a) She notices that if both magnets are dropped at the same time, the magnet on the plastic pole reaches the ground first. Explain this observation.



Cross section of magnet.

Copper pole

Plastic pole

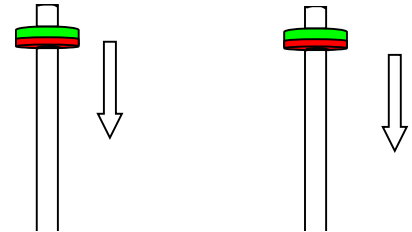

Description	Marks
As the magnet moves down the pole the flux through a cross section of the pole changes. This induces a current in the pole which establishes a flux that opposes the change in flux and a magnetic dipole that opposes the motion of the magnet	1-2
The copper pole is a conductor and the plastic pole is not. Therefore the plastic pole cannot establish eddy currents or opposing flux.	1
	3

(3)

- b) If the flux density of the magnet sliding down the copper pole was doubled and its mass was also doubled, would the time it takes to reach the bottom of the pole increase, decrease or stay the same. Circle your choice and explain your answer.

Increase decrease **stay the same** impossible to determine

Description	Marks
Stays the same	1
Weight force down doubles, $F(\text{magnetic})$ up doubles Therefore ΣF also doubles (at any given time in the motion)	1
$\Sigma F_2 = 2 \times \Sigma F_1$ $\text{acceleration}_1 = \Sigma F_1/m$ $\text{acceleration}_2 = 2\Sigma F_1/2m = \text{acceleration}_1$ Or words to that effect.	1
	3

(3)

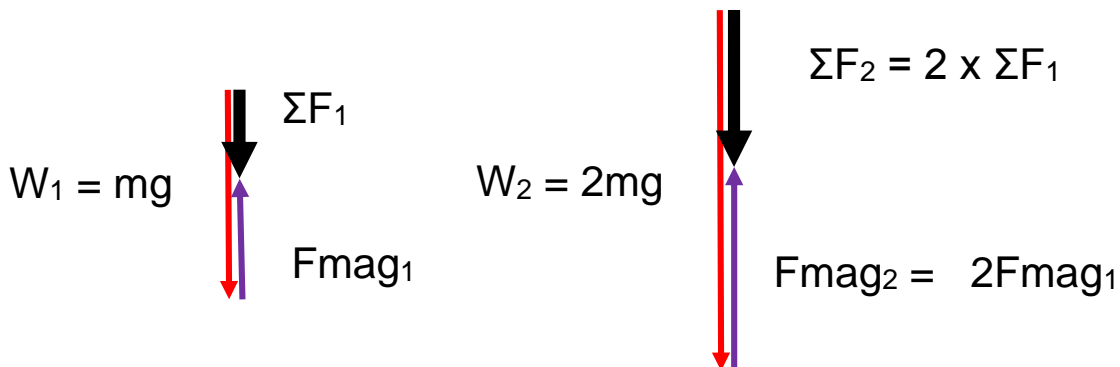

Question 11

The diagram shows a sound engineer holding a microphone boom horizontally. The microphone has a mass of 8.00 kg and the boom arm has a length of 2.20 m and a mass of 1.40 kg. Dimensions are shown on the diagram. The sound engineer applies forces from his hands to the boom arm in a vertical direction.

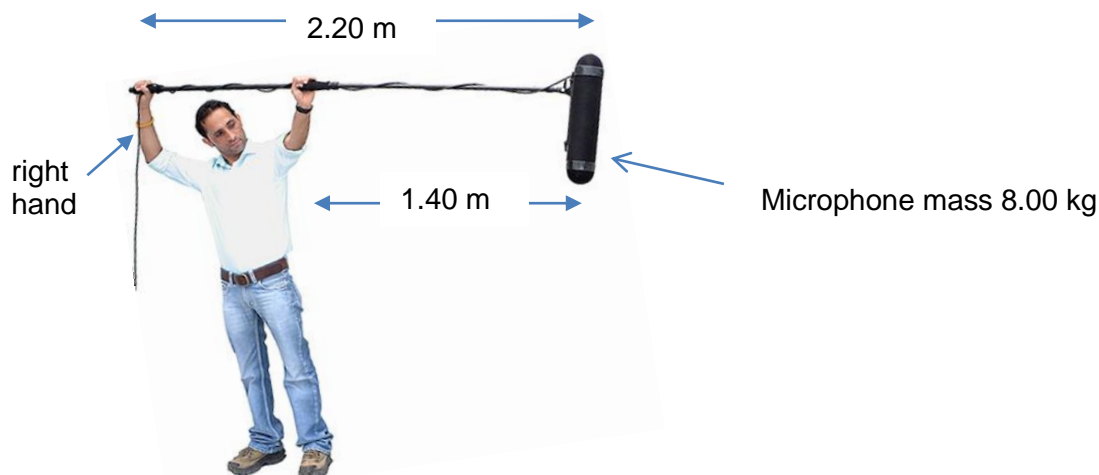

a) Draw a free body diagram showing the forces acting on the boom.

(1)

Description	Marks
<p>$F_{\text{right hand}}$ $F_{\text{left hand}}$ W_{boom} $W_{\text{microphone}}$</p>	1
Total	1

b) Calculate the force acting on the sound engineer's left and right hands.

(4)

Description	Marks
$W_{mic} = 8.00 \times 9.8 = 78.4 \text{ N}$ $W_{boom} = 1.4 \times 9.8 = 13.72 \text{ N}$	1
$\Sigma T_L = 0$ (taking moments from left hand) $F_R \times 0.8 = W_{mic} \times 1.4 + W_{boom} \times 0.3$ $F_R = \frac{78.4 \times 1.4 + 13.72 \times 0.3}{0.8}$	1
$= 142 \text{ N (down)}$	1
$F_L = 78.4 + 13.72 + 142 = 234 \text{ N (up)}$	1
Total	4

Question 12

A Boeing KC-135R Stratotanker, which has a wingspan of 39.9 m, takes off from Singapore airport which is near the equator. It then heads directly South. After taking off, the plane ascends at a speed of 237 m s^{-1} at 5.00° to the horizontal. The magnetic field lines at Singapore airport can be considered to be horizontal and the magnetic flux density is $4.70 \times 10^{-5} \text{ T}$.



- a) Calculate the potential difference between the tips of each wing of the Stratotanker as it ascends

Description	Marks
$emf = lvB \sin \theta$	1
$= 39.9 \times 237 \times 4.70 \times 10^{-5} \sin 5$	
$= 3.87 \times 10^{-2} \text{ V}$	1
Total	2

- b) Which location on the wingspan will become positively charged? Circle your choice and explain your answer.

Western wing Middle of the wings Eastern Wing Impossible to determine

(2)

Description	Marks
Western wing	1
Using the right rule ($emf = lvb$) the western wing becomes positively charged. The velocity component perpendicular to the flux is up, the flux is horizontal to the north and emf is towards the west.	1
Total	2

Question 13

A porter is standing still and supporting a trolley that is loaded with boxes. The combined mass of the trolley and boxes is 84 kg. The trolley is free to rotate about frictionless wheels at its base. The porter applies a force vertically upwards on the handles to maintain equilibrium. The diagram on the right is to scale.

Estimate the net force that the porter applies to the trolley. You must provide reasonable estimates for all data required to answer the question and give your answer to 2 significant figures.



Description	Marks
Reasonable estimates provided Horizontal distance between wheel and hands - allowable range 0.30 – 0.9 m (0.6 m used for solution below) Horizontal distance between wheel and COM - allowed range 0.1 - 0.4 m but must be less than half of previous estimate (0.2 m used for solution)	1
Taking moment about horizontal level arms from wheel (all angles 90°) $\Sigma cwm = \Sigma acwm$ ($M = r.F.\sin\theta$) $0.6 \times F = 0.2 \times 84 \times 9.8$ $F = 274.4 \text{ N}$	1-2
$F = 2.7 \times 10^2 \text{ N}$ (significant figures)	1
Total	4

Continued on next page

SECTION 2: Problem Solving

Marks Allotted: 90 marks out of total of 180 marks (50%)

This section contains 7 questions. You should answer **ALL** of the questions and show **full working**.

Answer all questions in the spaces provided.

Question 1 [16 marks]

The diagram shows a planet of unknown mass. It has a moon of mass 9.23×10^{23} kg in a circular orbit. The orbital radius of the moon around the planet is 4.83×10^9 m. It takes the moon 44 Earth days to go around the planet. The moon has a diameter of 14 700 km.

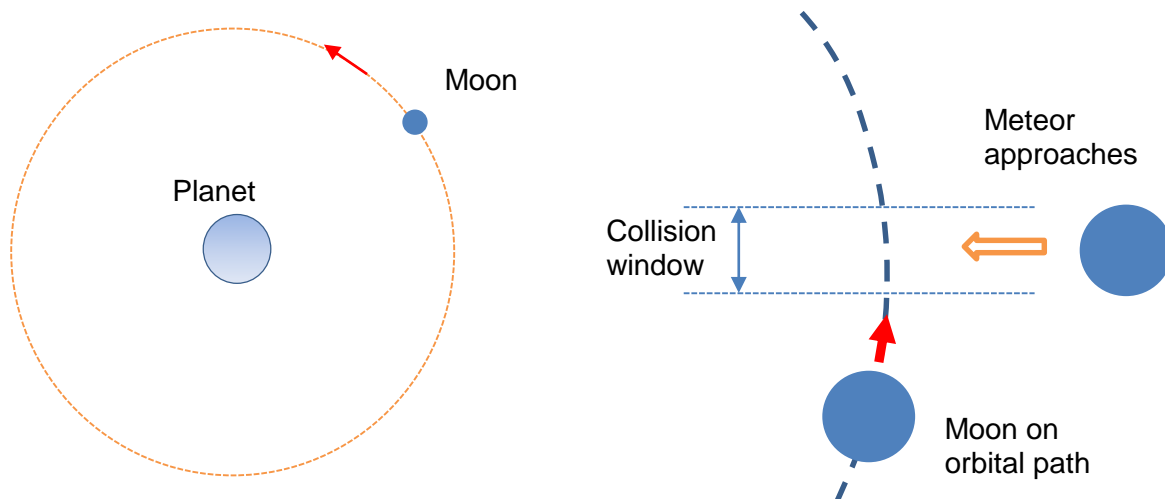

a) Calculate the gravitational field strength of the moon at an altitude of 7 000 km above its

Description	Marks
Radius = $7\,350\,000 + 7\,000\,000$ m = $14\,350\,000$ m	1
$g = G \frac{M}{r^2}$	1
$g = 6.67 \times 10^{-11} \frac{9.23 \times 10^{23}}{14\,350\,000^2}$	
$g = 0.299 \text{ N kg}^{-1}$	1
Total	3

b) Calculate the orbital speed of the moon.

Description	Marks
$T = 44 \times 24 \times 60 \times 60 = 3\,801\,600$ s	1
$v = \frac{2\pi r}{T}$	1
$v = \frac{2\pi \times 4.83 \times 10^9}{3\,801\,600}$	
$v = 7.98 \times 10^3 \text{ m s}^{-1}$	1
Total	3

- c) Calculate the mass of the planet based only on the data given in the question. You must derive an equation that only considers the variables of mass m , separation r , time period T and the universal gravitational constant G .

(4)

Description	Marks
Conceptual understanding: $\frac{v^2}{r} = G \frac{M}{r^2}$ let $v = \frac{2\pi r}{T}$ and derive $\frac{4\pi^2 r}{T^2} = G \frac{M}{r^2}$ $M = \frac{4\pi^2 r^3}{GT^2}$	1
$M = \frac{4\pi^2 (4.83 \times 10^9)^3}{6.67 \times 10^{-11} \times (3\,801\,600)^2}$	1-2
$M = 4.61 \times 10^{27} \text{ kg}$	1
Lose 1 mark if previous value of v used instead of derivation	
Total	4

- d) A meteor which is the same size as the moon is heading directly towards the planet from deep space and on the same plane as the orbit. It is possible that it could collide with the moon if it passes through the moon's orbit at the same time that the moon is in that location (the "collision window" detailed on the diagram). Consider one complete orbital period and calculate the time in minutes that the moon is in this "collision window".

Description	Marks
Orbital speed = $7.98 \times 10^3 \text{ m s}^{-1}$ (Orbital Circumference = $2\pi r = 2\pi \times 4.83 \times 10^9 = 3.0347785 \times 10^{10} \text{ m}$ which can be used for a solution using the ratio of 2 diameters in one circumference if one circumference equates to 44 days)	1
Understands that moon must progress 2 diameters to be in and then out of collision window $s = 2 \times 14\,700\,000 = 29\,400\,000 \text{ m}$	1
$t = \frac{s}{v_{av}} = \frac{29\,400\,000}{7.98 \times 10^3} = 3684.21 \text{ seconds}$	1
Time minutes = $3684.21 / 60 = 61.4 \text{ minutes}$	1
Total	4

- e) If the meteor "just misses" an impact with the moon it is possible that it will also miss an impact with the planet even though it was originally on a collision course with the planet. Explain why this is so.

Description	Marks
As the meteor passes the moon its straight line path will be deviated by the gravitation pull of the moon. Therefore it will not continue directly towards the planet. (FYI This is known as a slingshot effect.)	1-2
Total	2

2)

Question 2 [12 marks]

The Snowy Mountains Scheme is a 3950 megawatt (MW) hydro-electric power generation project located in Australia's Southern Alps. It comprises 7 main power stations and the Scheme produces on average around 4,500 gigawatt hours each year of clean renewable energy for the National Electricity Market. In doing so, the Scheme prevents around 4,500,000 tonnes of carbon dioxide being released each year. That's the equivalent of the exhaust from around 1 million cars.

- a) The Tumut 1 power station is part of the Snowy Mountains Scheme. It produces 330 MW of power at 330 kV and supplies this energy to parts of Sydney. Calculate the current running through the electrical cables between Tumut 1 and Sydney (You may consider this situation as a simple series circuit).

(2)

Description	Marks
$I = \frac{P}{V} = \frac{330 \times 10^6}{330 \times 10^3}$	1
$= 1000 \text{ A}$	1
Total	2

- b) Assuming that the resistance of the cables between Tumut 1 and Sydney is 10.00Ω and the current through the cables is 1000 A, calculate the potential difference (voltage drop) across the cables.

(1)

Description	Marks
$V = IR = 1000 \times 10 = 10.0 \text{ kV}$	1
Total	1

- c) Calculate the power transformed to heat in the cables if the current through the cables is 1000 A.

(2)

Description	Marks
$P = I^2 R$	1
$= 1000^2 \times 10$	
$= 10.0 \text{ MW} \text{ (} 1.00 \times 10^7 \text{ W)}$	1
Total	2

- d) Determine the percentage of power lost while travelling through the cables.

(2)

Description	Marks
$\% \text{ lost} = \frac{10}{330} \times 100$	1
$= 3.03 \%$	1
Total	2

- e) Explain why voltage is stepped up and current stepped down by transformers before the power is transmitted over long distances. (1)

Description	Marks
Voltage is stepped up and current is stepped down to reduce the I^2R heating losses.	1
Total	1

- f) The 330 kV voltage is stepped down to 66 kV by another transformer when it reaches a city. There are 5000 turns on the primary coil and 1000 turns on the secondary coil. This transformer is 100% efficient in terms of flux linkage but only 86.0% efficient in terms of power transfer from primary to secondary. The power on the primary side is 320 MW. Calculate the current in the secondary coils. (2)

Description	Marks
$P_s = I_s V_s$ $0.86 \times 320 \times 10^6 = I_s \times 66000$ $I_s = \frac{0.86 \times 320 \times 10^6}{66000}$	1
$I = 4169.69697 = 4.17 \times 10^3 A$	1
Total	2

- g) Explain why a transformer only operates with AC power and not DC power. (2)

Description	Marks
When AC power is used the current in the primary coil continually varies. This varies the flux produced by the primary coil which changes the flux through the secondary coil. The changing flux in the secondary coil induces an emf which produces a current.	1
When DC power is used current on the primary coil does not vary and no emf is induced in the secondary coil.	1
Total	2

Question 3 [13 marks]

The diagram shows the AFL player Ben Graham as he kicks a goal for Geelong. The ball travels a horizontal distance of 113 m and crosses the goal posts at a vertical height of 22.5 m. The ball leaves his foot at ground level with an angle of elevation of 52.0° . You can ignore air resistance in this question.

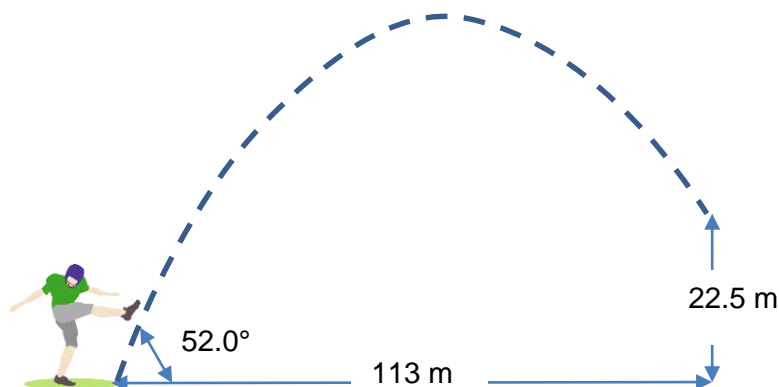

Description	Marks
$s_h = +113 \text{ m}$ $u_h = u \cdot \cos 52$ (correctly identifies variables) $s_h = u \cdot \cos 52 \times t_f$ substitution:	1
$t_f = \frac{s_h}{u \cdot \cos 52} = \frac{113}{u \cdot \cos 52}$	1
$s_v = +22.5 \text{ m}$ $a = -9.8$ $u_v = u \cdot \sin 52$ (correctly identifies variables)	1
$s_v = u_v t_f + \frac{1}{2} a (t_f)^2$ $+22.5 = u \cdot \sin 52 \cdot t_f - 4.9 (t_f)^2$	1
By further substitution $+22.5 = u \cdot \sin 52 \cdot \frac{113}{u \cdot \cos 52} - 4.9 \left[\frac{113}{u \cdot \cos 52} \right]^2$	1
$+22.5 = 144.6334 - \left[\frac{165070.3262}{u^2} \right]$	
$\left[\frac{165070.3262}{u^2} \right] = 144.6334 - 22.5$	
$165070.3262 = 122.1334 \cdot u^2$	1
$u^2 = 1351.557561$ $u = 36.7635 = 36.8 \text{ m s}^{-1}$	1
Total	7

Question 4 [11 marks]

The diagram shows a cart on a roller coaster track. The cart of mass 2400 kg is already moving at a height of 25.0 m. It follows the track and goes over the apex at 18.0 m s⁻¹. The apex is a section of the track which is the arc of a circle of radius 40.0 m and is 10.0 m high. You can ignore friction and air resistance for this question.

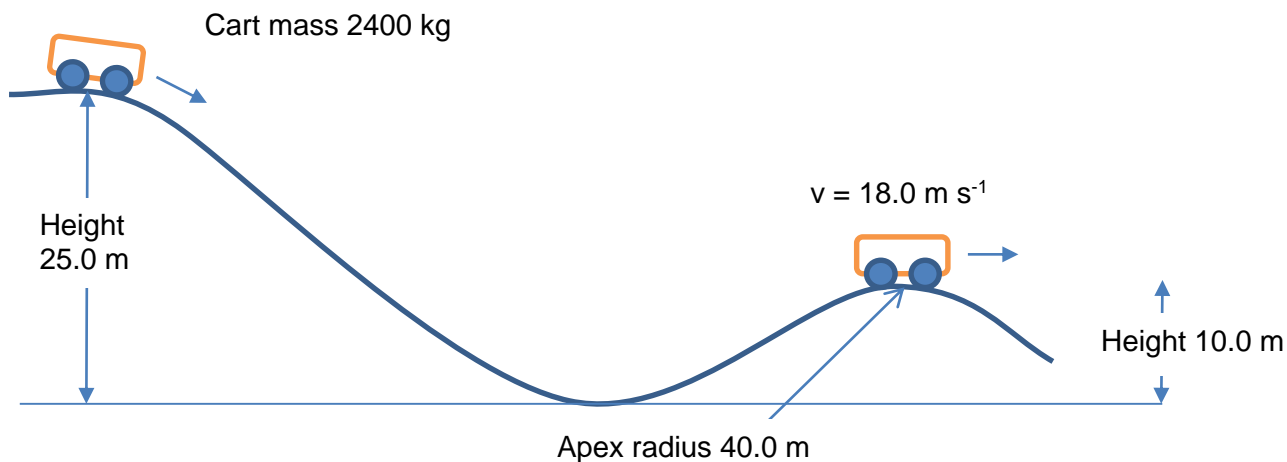

- a) Use the principle of conservation of mechanical energy to calculate the initial speed of the cart when it is at a height of 25.0 m.

(4)

Description	Marks
Conceptual understanding <i>TME is constant so,</i> $\frac{1}{2}mu^2 + mgh_1 = \frac{1}{2}mv^2 + mgh_2$ $\frac{1}{2}u^2 + gh_1 = \frac{1}{2}v^2 + gh_2$, substitute correct values both sides $\frac{1}{2}u^2 + 9.8 \times 25 = \frac{1}{2}18^2 + 9.8 \times 10$	1-2
Simplify $\frac{1}{2}u^2 + 245 = 260$ $u^2 = 30$ $u = 5.48 \text{ m s}^{-1}$	1 1
Total	4

- b) Construct a vector diagram to show the forces acting on the cart at the apex. You must clearly indicate the sum of forces on this diagram.

(2)

Description	Marks
Correctly drawn 	1-2
Total	2

- c) Calculate the normal reaction force acting from the track onto the cart as it goes over the apex at a height of 10.0 m.

(3)

Description	Marks
$\Sigma F = \frac{mv^2}{r} = mg - N$ $N = mg - \frac{mv^2}{r}$	1
$N = 2400 \times 9.8 - \frac{2400 \times 18^2}{40}$	1
$N = 4080 \text{ N}$	1
Total	3

- d) Explain what would happen to the magnitude of the normal reaction force if the radius of the circular arc on the apex was changed to 30.0 m.

(2)

Description	Marks
$N = mg - \frac{mv^2}{r}$ refers to equation If r decreases then mv^2/r increases, subtracting a bigger number from fixed value of mg gives a smaller value of N	1-2
Total	2

Question 5 [13 marks]

The figure shows an AC generator where the mechanical torque is generated by turning a handle. At the instant shown the lengths of the coil are directly next to the poles of the magnets.

The coil is square and has a side length of 20.0 cm. It has 120 turns and is rotated at 90.0 rpm. The strength of the magnetic field is 920 mT.

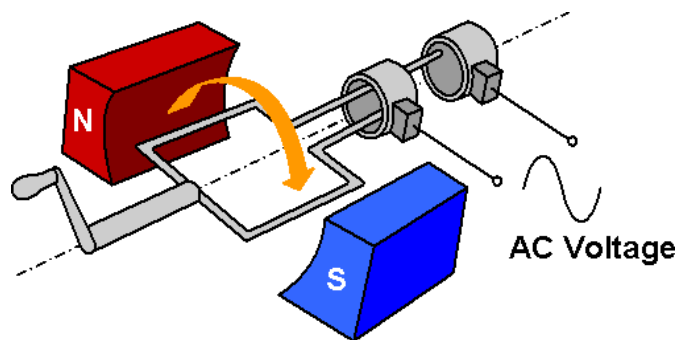

- a) Indicate on the diagram the direction of current flow at the instant shown. Explain your answer.

(2)

Description	Marks
Clockwise when viewed from the top.	1
The coil acts to oppose the increase in flux as it is rotated. Using the right hand grip rule this requires a current in the clockwise direction.	1
Total	2

- b) Calculate the speed of the length of coil beneath the North pole at the instant shown.

(3)

Description	Marks
$f = \frac{rpm}{60} = \frac{90}{60} = 1.5 \text{ Hz}$	1
$T = \frac{1}{f} = \frac{2}{3} \text{ s}$	
$v = \frac{2\pi r}{T}$ $= \frac{2 \times \pi \times 0.1}{\frac{2}{3}}$	1
$= 0.942 \text{ m s}^{-1}$	1
Total	3

- c) Assuming that the speed of the length of coil beneath the North pole is 0.943 m s^{-1} , calculate the maximum *emf* produced by the generator.

(2)

Description	Marks
$emf = 2 \times NlvB$ $= 2 \times 120 \times 0.2 \times 0.943 \times 0.920$	1
$= 41.6 \text{ V}$	1
Total	2

- d) If the speed of rotation of the coil is increased would the torque required to turn the coil increase, decrease or stay the same. Circle your answer and explain your choice

increase

decrease

stay the same

(3)

Explanation:

Description	Marks
Increase	1
The faster the rotation rate of the coil the greater the current induced in the coil.	1
The larger the current the greater the force and therefore torque which opposes the motion of the coil (Right hand rule with current in the direction of induced emf)	1
Total	3

- e) On the graph below sketch the emf (% of maximum) versus time for one rotation from the start position shown in the diagram. Put appropriate numerical values and units on the time axis.

(3)

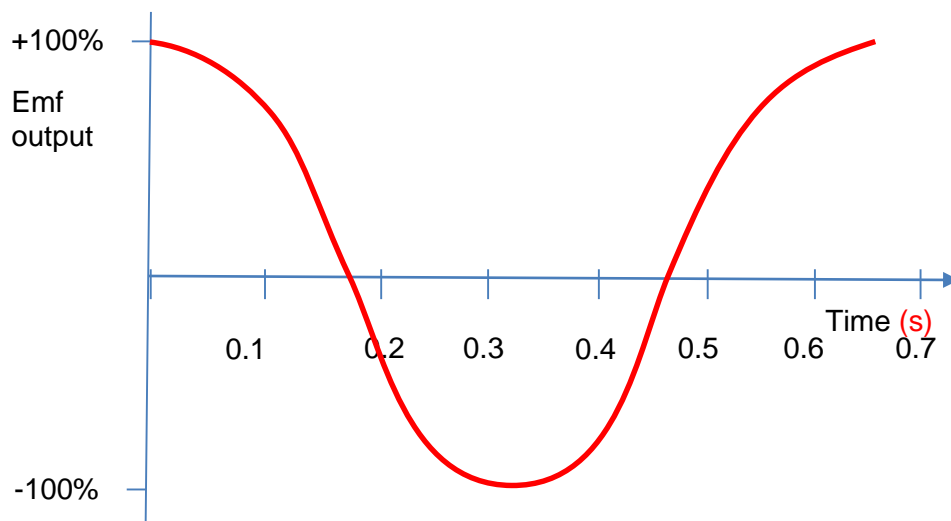

Starts at 100% ✓
 One full wave cosine shape ✓
 Labels seconds and a divisions such that 1 period at approx. 0.667 s ✓

Question 6 [11 marks]

The diagram shows a knight and horse on a drawbridge which is pivoted at the left hand edge. The drawbridge is 8.00 m long and has a uniform mass of 900 kg. It is not horizontal. The knight and horse have a combined mass of 750 kg and their centre of mass acts on the drawbridge at a distance of 7.00 m from the pivot. A rope is attached to the drawbridge at a distance of 5.00 m from the pivot. Important angles are shown on the diagram. The wall where the pivot is attached is vertical.

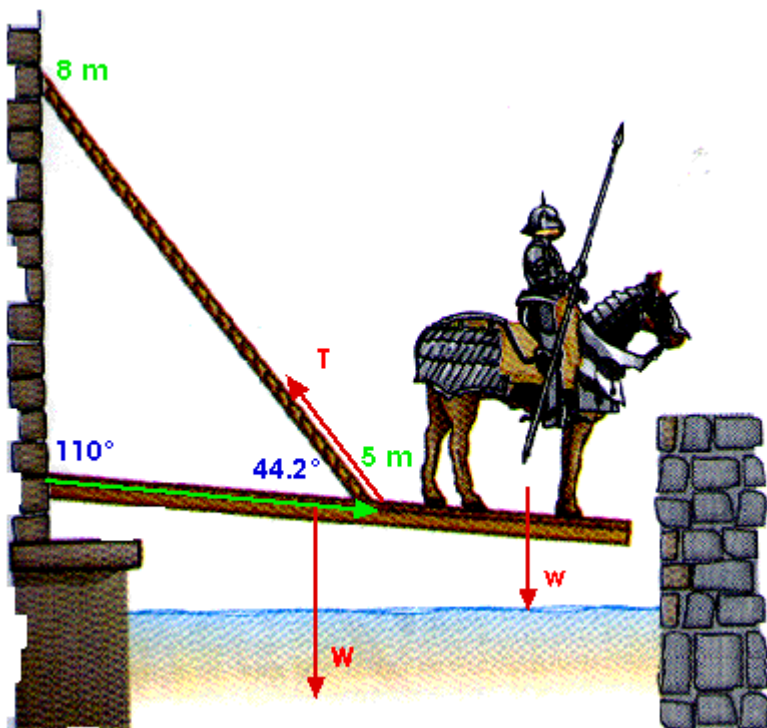

a) Calculate the tension in the rope.

(4)

Description	Marks
Principle of moments ΣM from pivot point are balanced Correctly identifies variables	
$\Sigma acwm = \Sigma cwm$ $r_T \cdot F_T \sin \theta_T = r_W \cdot F_W \sin \theta_W + r_H \cdot F_H \sin \theta_H$ $5 \cdot F_T \sin 44.2 = r_W \cdot F_W \sin \theta_W + r_H \cdot F_H \sin \theta_H \quad \text{LHS}$ $5 \cdot F_T \sin 44.2 = (4 \times 900 \times 9.8 \sin 110) + (7 \times 750 \times 9.8 \sin 110) \quad \text{RHS}$	1 1
$F_T = \frac{(4 \times 900 \times 9.8 \times \sin 110) + (7 \times 750 \times 9.8 \sin 110)}{5 \times \sin 44.2}$	1
$F_T = 23380.2698 \text{ N} = 2.34 \times 10^4 \text{ N}$	1
Total	4

- b) Calculate the reaction force that the pivot exerts on the drawbridge. Note that this is a vector quantity that has magnitude and direction and it acts below the horizontal. If you could not solve for the tension in part a) then use a value of 23 380 N.

(5)

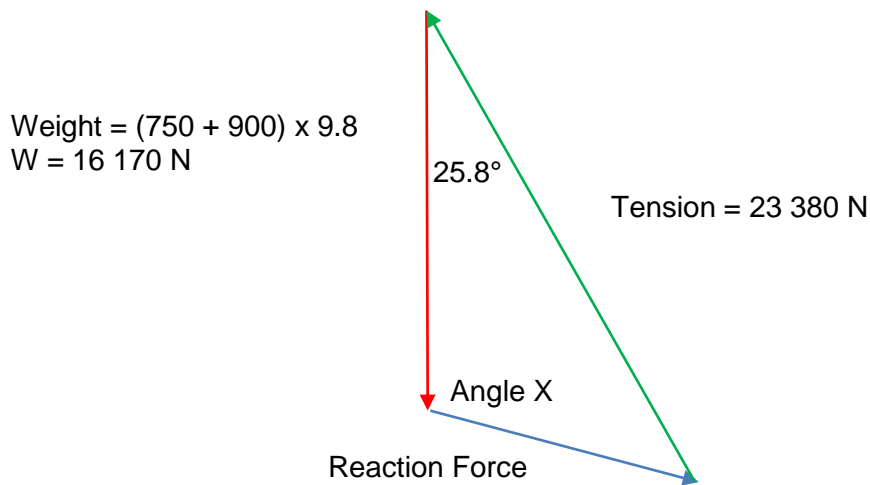

Description	Marks
Correctly identifies variable and angles Calculate magnitude of Reaction from cosine rule $R^2 = W^2 + T^2 - 2 \cdot T \cdot W \cdot \cos(25.8)$	1
$R^2 = 16170^2 + 23380^2 - 2 \times 16170 \times 23380 \cdot \cos(25.8)$	1
$R = 11285.122 = 1.13 \times 10^4\text{ N}$	1
$\frac{T}{\sin X} = \frac{R}{\sin 25.8}$ $\frac{23380}{\sin X} = \frac{11285.122}{\sin 25.8}$	1
$X = 115.6^\circ$ (reject 64.4° as acts below the horizontal) Therefore angle of reaction for is 25.6° before the horizontal	1
Solution by components: $F_h = 10175\text{ N}$, $F_v = -4879\text{ N}$	
Total	5

- c) Explain what changes will occur to the tension in the rope if the horse walks backwards toward the castle.

(2)

Description	Marks
Clockwise torque due to the weight force of horse will decrease because lever arm is decreasing.	1
The counter torque to keep this in equilibrium is therefore less so the tension can decrease (for its fixed lever arm)	1
Total	2

Question 7 [14 marks]

The figure shows a simple DC motor used to power an electric car.

The parameters of the motor are as follows:

- Length of sides AB and CD = 4.00 cm
- Length of side CB = 3.00 cm
- Number of turns = 10
- Flux density of the magnets = 10.0 mT

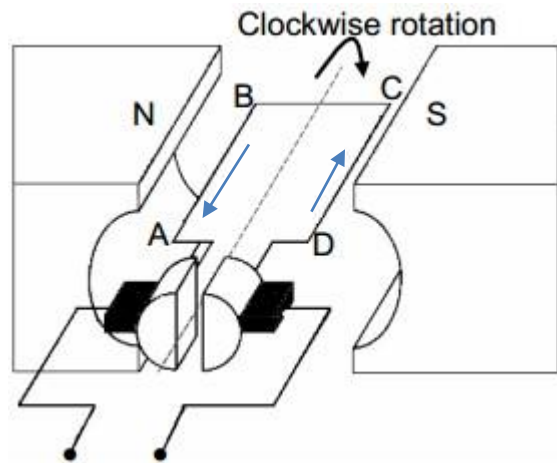

a) Indicate on the diagram the direction of conventional current flow if the motor turns in the direction shown. (1)

b) Explain how the motor produces torque in the position shown. (3)

Description	Marks
The DC power supply provides an emf which produces current through the coil.	1
Using the right hand rule ($F=ILB$) the current in the conductors adjacent to the poles produce a force which is at right angles to the flux and current.	1
This force then acts on a lever arm and produces torque. ($T = rF$)	1
Total	3

c) If the maximum torque applied by the motor is 1.20 Nm, calculate the current which runs through the coils. (3)

Description	Marks
$A = 0.04 \times 0.03 = 1.20 \times 10^{-3} \text{ m}^2$	1
$T = INBA$ (or $T(\text{max}) = 2rF\sin(90) = 2 \times \frac{w}{2} \times B \cdot I \cdot \ell \cdot N$)	1
$I = \frac{T}{NBA}$	
$= \frac{1.20}{10 \times 0.01 \times 1.20 \times 10^{-3}}$	
$= 10,000 \text{ A}$	1
Total	3

d) If the coil rotates 30.0° from the position shown, calculate the torque produced by the motor as a percentage of the maximum motor torque. (1)

Description	Marks
$\% \text{ max} = \sin(60) \times 100 = 86.6 \%$	1
Total	1

- e) What would happen to the current in the coil as the car begins to travel uphill? It maintains the same constant speed as on horizontal ground. Circle the correct answer and explain your choice. (3)
- Increase decrease stay the same impossible to determine

Description	Marks
Increase.	1
As the car travels up the hill the rotation would slow which would decrease the back emf. As the back emf decreases the net voltage used to produce current will increase which will increase the current. Or, an argument based on more work required to be done to transform GPE into the car. Therefore power output must increase to supply more energy. $P = VI$ for a fixed voltage so I must increase.	1-2
Total	3

- f) Explain how the commutator and brush arrangement works and why it is necessary on a DC motor. (3)

Description	Marks
Current passes through the brush and into the commutator and coil.	1
The commutator allows the direction of current in a side of the coil to reverse when the coil is 90° to the position shown. It then reverses every 180° .	1
This allows the force applied to a side of the coil under a pole to always be in one direction. This produces an applied torque in only one direction.	1
Total	3

End of Section B

SECTION C: Comprehension and Interpretation

Marks Allotted: 36 marks out of total of 180 marks (20%)

Question 1 [18 marks]

Rotary encoders are common instruments used to determine the angle of rotation and speed of a shaft or gear. They are used in many applications that require precise shaft and gear positions such as robotics, special purpose photographic lenses and rotating radar platforms.

A magnetic pickup (shown in the figure) is a type of encoder which uses a magnet wrapped by a coil and an irregular rotating ferromagnetic member (such as a gear) to determine the position of the gear. In the figure shown the north pole of the permanent magnet induces a south pole in a gear tooth tip as a gear tooth moves beneath the permanent magnet and coil.

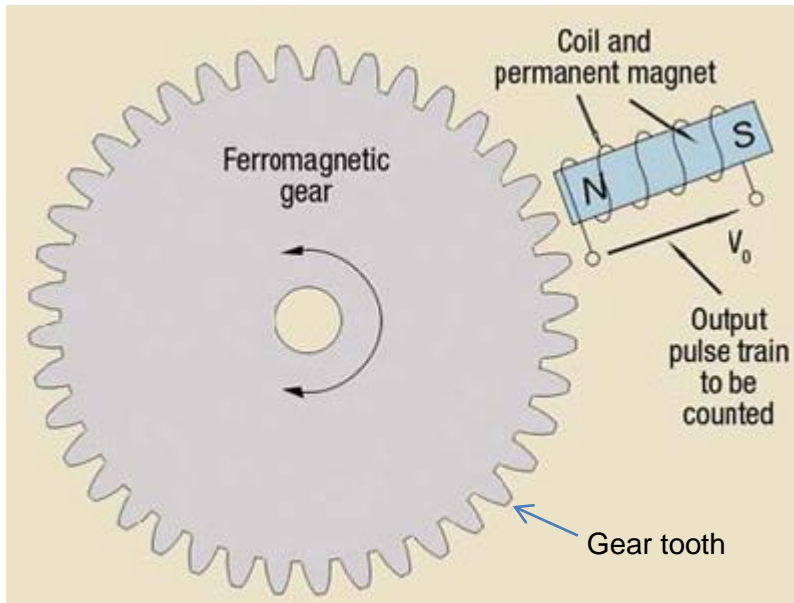

The magnetic flux produced by the gear tooth changes the magnetic flux through the coil. The change in magnetic flux through the coil then induces an emf in the coil. The magnetic flux density produced by the gear tooth as it moves beneath the coil and the corresponding emf induced in the coil are shown in the figures below.

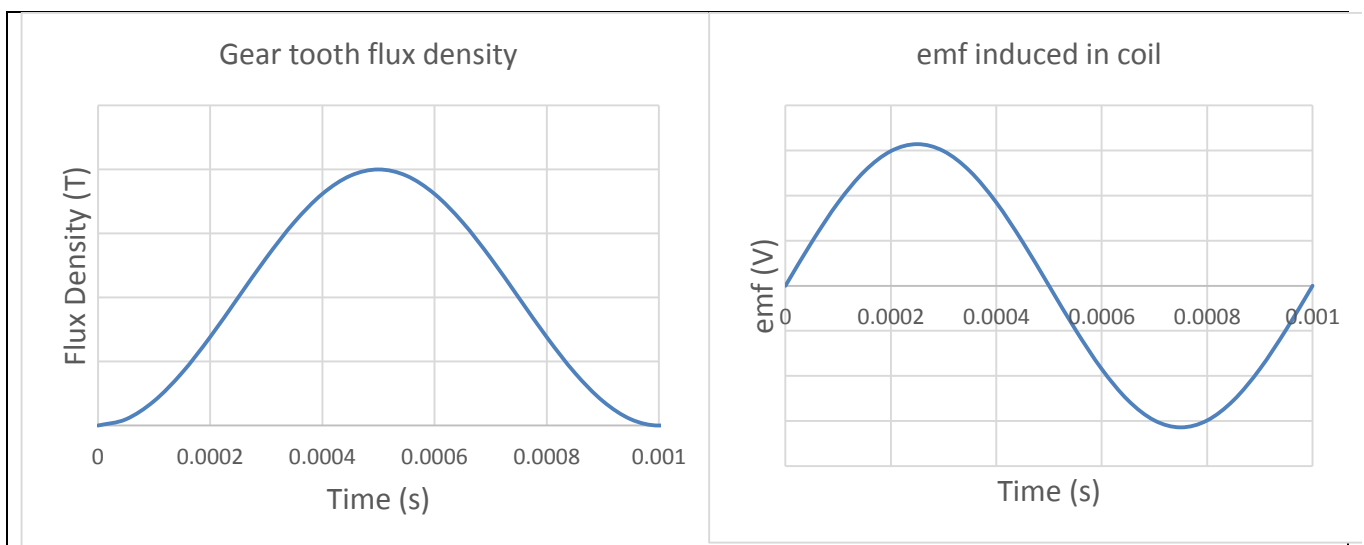

Consider a gear with a number of teeth denoted by N_G and a period of rotation denoted by T . During one revolution each gear tooth will be below the coil for the following time;

$$\Delta t_G = \frac{T}{N_G}$$

The time that it takes for the gear tooth flux density to increase from a minimum to a maximum is equal to half of the time that the gear tooth is below the coil.

$$\Delta t = \frac{\Delta t_G}{2} = \frac{T}{2N_G}$$

To estimate the average emf induced in the coil we can approximate the change in magnetic flux density by the following equation;

$$emf_{avg} = - \frac{\Delta \Phi}{\Delta t} = \frac{NB_{max}A}{\Delta t} = \frac{NB_{max}\pi D^2}{4\Delta t}$$

where:

- B_{max} is the maximum magnetic flux density produced by the coil (T)
- A is the cross sectional area of the coil (m^2)
- D is the diameter of the coil (m)
- N is the number of turns in the coil.

Combining the above equation with the time equation gives the following approximation for the average emf induced in the coil.

$$emf_{avg} = \frac{N \cdot N_G \cdot B_{max} \cdot \pi \cdot D^2}{2T}$$

Answer the following questions.

- a) Explain why the emf induced in the **coil reverses** as a gear tooth tip passes underneath the coil.

(3)

Description	Marks
<p>The gear tooth is ferromagnetic. When under the influence of the magnetic field of the permanent magnet a south pole is induced on the gear tip. When the tip approaches the coil the net flux through the coil begins to increase. This induces an emf in the coil which creates a flux that opposes the increase in flux through the coil.</p> <p>As the south pole moves away from the coil the flux through the coil begins to decrease. This induces an emf in the coil which acts to oppose the decrease in flux.</p> <p>The induced emfs are in opposite directions as the first scenario opposes an increase in flux and the second scenario opposes a decrease in flux.</p>	1-3
Total	3

- b) The first graph below shows the emf induced in the coil. On the second graph sketch the emf induced in the coil if the gear reverses its direction of rotation.

(2)

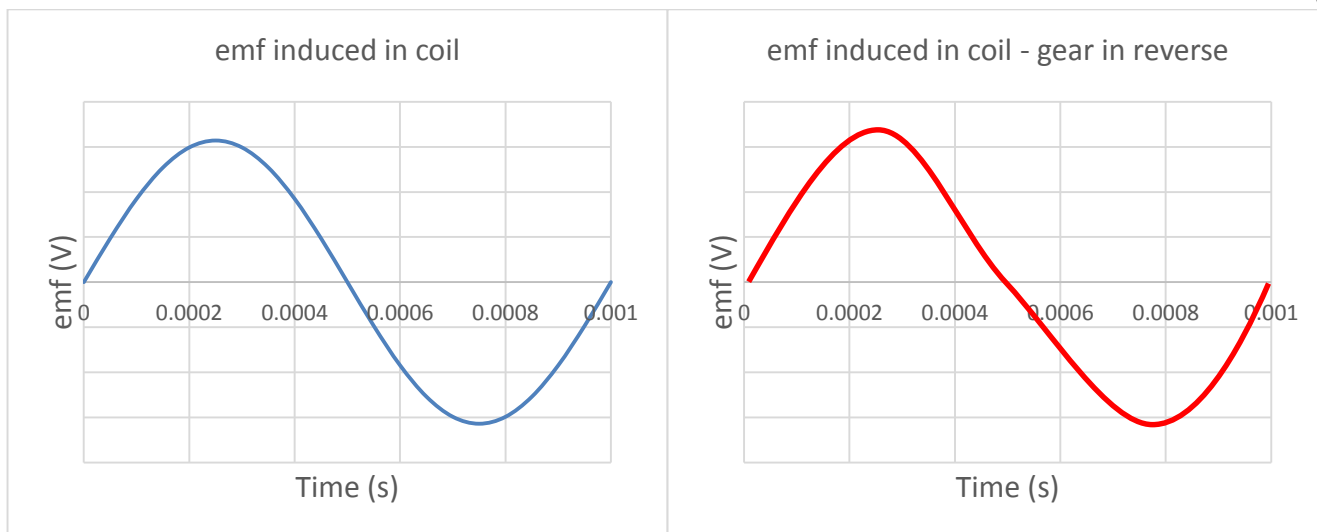

Briefly explain your response.

Description	Marks
Sketches the coil output exactly the same as before.	1
Even though the rotation of the gear reverses the emf is still a response to a south pole approaching and then receding (regardless of direction)	1
Total	2

- c) The first graph below shows the emf induced in the coil. On the second graph sketch the emf induced in the coil if the permanent magnet is reversed so that the South pole faces the ferromagnetic gear. Briefly explain your response.

(3)

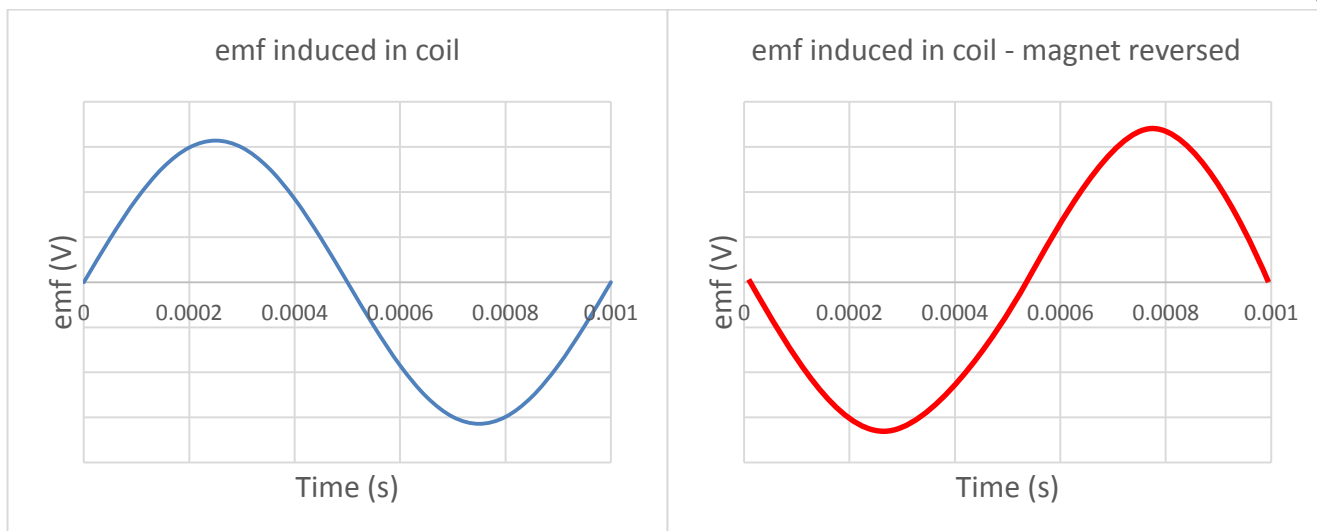

Briefly explain your response.

Description	Marks
The emf output would be reversed	1
A north pole would now be established in the gear tooth which would reverse the direction of magnetic flux in the coil. This would reverse the change in flux direction which reverses the emf induced in the coil.	1-2
Total	3

Consider a gear and magnetic pickup with the following values:

number of gear teeth:	$N_G = 60$
rotation rate:	$f(\text{rpm}) = 1000 \text{ rpm}$
maximum flux density:	$B_{\text{max}} = 0.2 \text{ T}$
coil diameter:	$D = 0.01 \text{ m}$

d) Demonstrate by calculation that the period of rotation is 0.0600 s.

(2)

Description	Marks
$f(\text{Hz}) = \frac{f(\text{rpm})}{60} = 16.667 \text{ Hz}$	1
$T = \frac{1}{f} = 0.0600 \text{ s}$	1
Total	2

e) Calculate how many turns the coil should have to generate an emf of 3.77 V when the gear has a rotational period of 0.0600 s. Round your answer to the nearest whole number.

(2)

Description	Marks
$emf_{\text{avg}} = \frac{NN_G B_{\text{max}} \pi D^2}{2T}$ $N = \frac{2T \times emf_{\text{avg}}}{N_G B_{\text{max}} \pi D^2}$ $= \frac{2 \times 0.06 \times 0.314}{60 \times 0.14 \times \pi \times 0.01^2}$	1
$= 120 \text{ turns}$	1
Total	2

The graph below gives the magnetic flux density in the coil produced by a single gear tooth. The time axis indicates the time that the gear tooth is exposed to the magnetic flux of the permanent magnet.

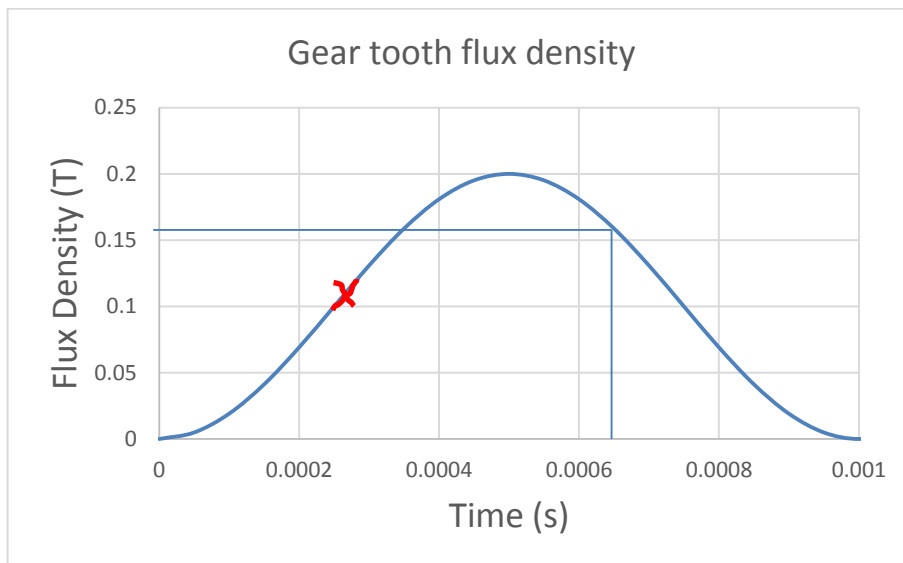

- f) With reference to the graph state the magnetic flux density at a time of $6.50 \times 10^{-4} \text{ s}$. If the area of the coil is $3.14 \times 10^{-4} \text{ m}^2$. Use the magnetic flux density value that you stated to calculate the flux through the coil.

Description	Marks
$B = 0.16 \text{ T}$ (clearly estimated from graph)	1
$\Phi = BA = 0.16 \times 3.14 \times 10^{-4} = 5.02 \times 10^{-5} \text{ Wb}$	1
Total	2

- g) Explain why the flux density produced by the gear tooth is a maximum when the gear tooth is beneath the coil-permanent magnet assembly.

(2)

Description	Marks
The magnetic flux induced in the ferromagnetic gear tooth increases as the gear tooth approaches the permanent magnet assembly because the gear tooth is exposed to more of the magnetic field from the permanent magnet. This aligns more domains in the gear tooth which increases the flux density established in the gear tooth.	1-2
Total	2

- h) On the graph above place a cross where flux density increases at the fastest rate. Explain why this also corresponds to the maximum emf induced in the coil.

(2)

Description	Marks
Cross in correct position midway along rise	1
Maximum emf induced in the coil is proportional to the rate of change of flux. As rate of change of flux increases at the fastest rate at this point, emf is the largest.	1
Total	2

Question 2 [18 marks]

Students were investigating the simple harmonic motion of a mass oscillating on a spring. The purpose was to determine the value of the spring constant for that particular spring. The spring constant is a measure of the stiffness of a spring. The experimental set up is shown in the diagram below. A mass carrier was attached to the spring as in (a). The mass was pulled down by a displacement Δy as in (b). The mass was then released so that it oscillated up and down on the spring. The time for 20 oscillations was recorded with a stopwatch. This was repeated for a range of mass values. Results are shown in the table below.

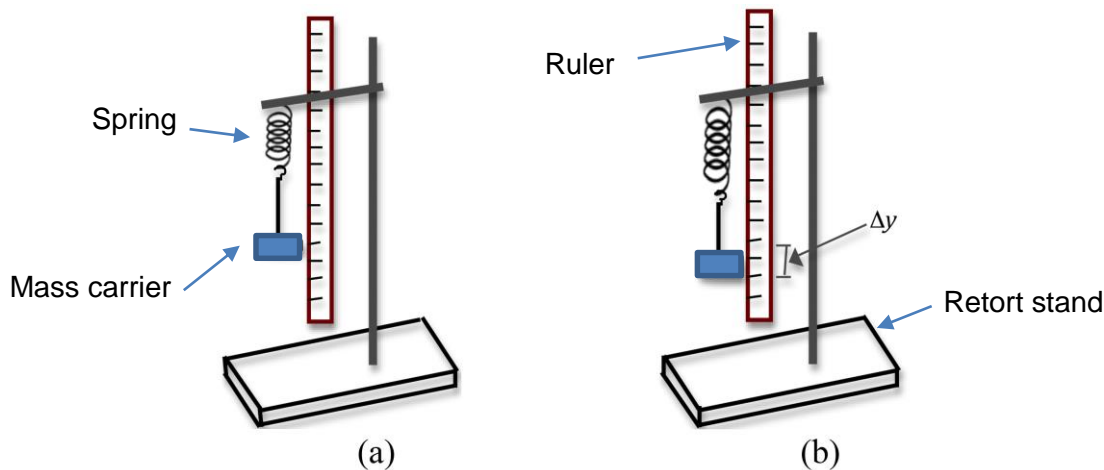

It can be shown that the period of oscillation T (s), is related to the other factors in this experiment by the following equation, where m is the **mass (kg)** of the mass carrier that is oscillating and k is the value of the spring constant (N m^{-1}).

$$T = 2\pi \sqrt{\frac{m}{k}}$$

Mass value (g)	Mass (kg)	Time for 20 oscillations (s)	Period T (s)	Period squared T^2 (s ²)
300	0.300	12.36	0.618 ± 0.031	0.382 ± 0.038
350	0.350	13.36	0.668 ± 0.033	0.446 ± 0.045
400	0.400	14.08	0.704 ± 0.035	0.496 ± 0.050
450	0.450	15.00	0.750 ± 0.038	0.563 ± 0.056
500	0.500	16.08	0.804 ± 0.040	0.646 ± 0.065
550	0.550	16.78	0.839 ± 0.042	0.704 ± 0.070

For this experiment the time values recorded with a stopwatch had an uncertainty of $\pm 5\%$

- a. Manipulate the data in the table so that you can plot a straight line graph of period T^2 (s²) versus mass (kg). You must indicate the absolute uncertainty of all time related values. Some of the values have been done for you. (2)
- b. You will be plotting T^2 (s²) on the vertical axis and **mass** (kg) on the horizontal axis to get a straight line graph of the general format $y = m \cdot x + c$
 The gradient of your graph will correspond to an average value of: (circle the correct response) (1)

a. $\frac{2\pi}{\sqrt{k}}$

b. $\frac{4\pi^2}{k}$

c. $\frac{\sqrt{k}}{2\pi}$

d. $\frac{k}{4\pi^2}$

c. Use the data to produce a graph below. You must use error bars to indicate the accuracy of the period squared values. You should break your axes appropriately as no analysis of the vertical intercept is required.

(5)

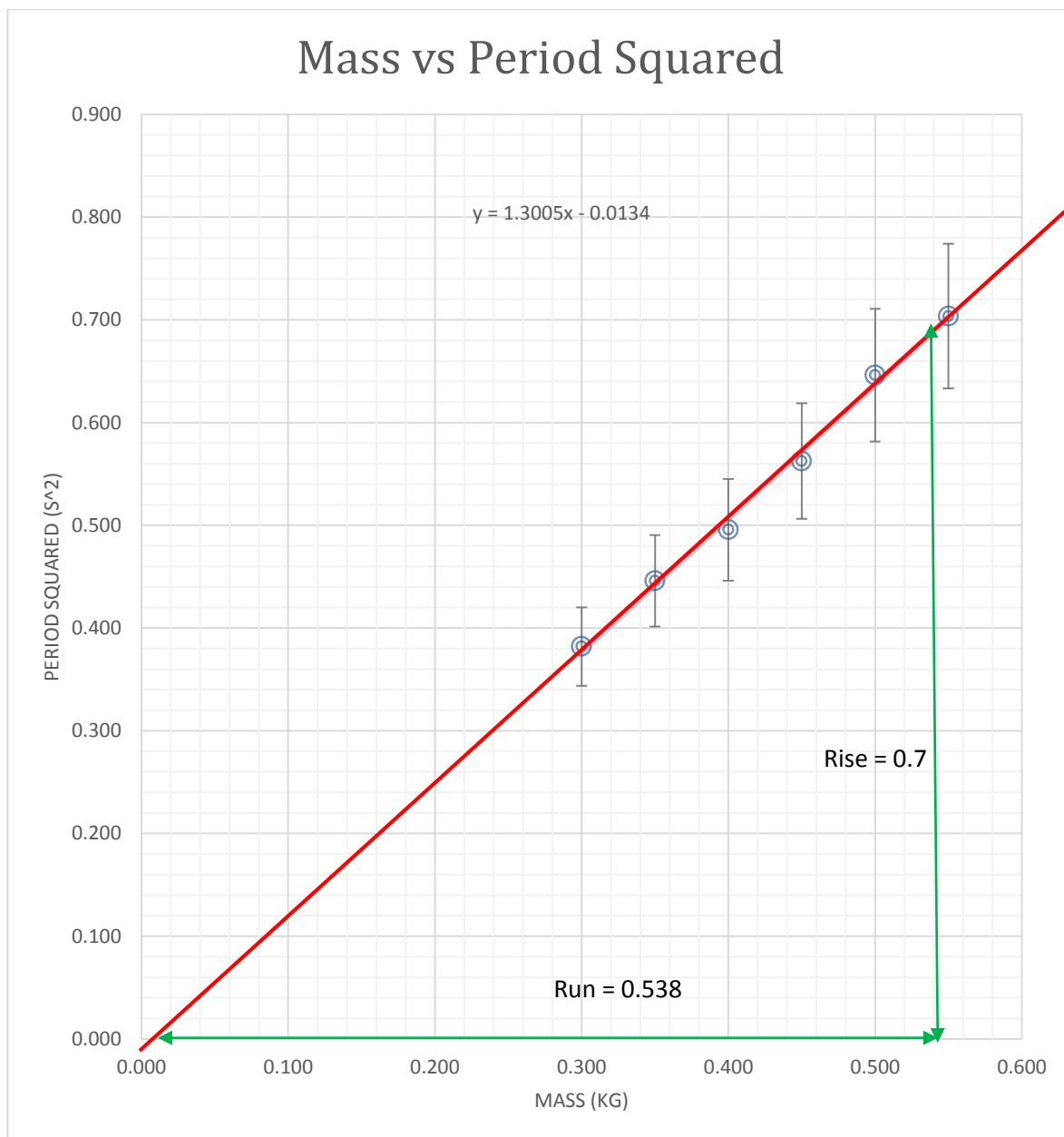

- Scaling ✓
- Axes labels ✓
- Axes Units ✓
- Plotting ✓
- Error bars ✓

- d. Calculate the gradient of your line of best fit from your graph. Clearly show the rise and run that you used on the graph.

(3)

Description	Marks
Determines rise from graph and clearly shown e.g. 0.700 Determine runs from graph and clearly shown e.g. 0.538	1
Gradient = rise / run = 0.700 / 0.540 m	1
Gradient = 1.30	
Total	2

- e. Determine the units of the gradient from your graph axes.

(2)

Description	Marks
taken from the graph axes (ie not equivalent derived unit)	1
s ² kg ⁻¹	1
Total	2

- f. From the gradient of your line of best fit, calculate of the spring constant (k) for the spring used in this experiment.

(3)

Description	Marks
$1.30 = \frac{4\pi^2}{k}$	1
$k = \frac{4\pi^2}{1.30}$	1
$k = 30.4 \text{ (N m}^{-1}\text{)}$	
Total	3

- g. It was later discovered that the students had, by mistake, only recorded the time for 19 oscillations instead of 20. This means that the value of the spring constant calculated in part f. was:
(Circle a response)

 Too high

 Not affected by this error

 Too low

 Impossible to determine

Explain briefly.

Description	Marks
The time data should have been greater than it was.	1
The gradient should have been higher than it was. $k = \frac{4\pi^2}{\text{gradient}}$	
Therefore the correct value of k would be lower So the value the students calculated was "Too high"	1
Total	2

END OF EXAM

Spare pages for additional working.